



Owner's Manual EN

DEM UPGRADE HEAD UNIT FOR 1998-2013 HARLEY DAVIDSON® STREET GLIDE MOTORCYCLES



HDHU.9813SG

Contents

Safety First	
Safety Definitions	2
Pre-Riding	
Check list	3
Care and cleaning	3
Screen	3
Appearance	3
Accessories & Installation	4
Headunit Control	5
Wiring	7
Harness	9
Operation	
Main menu	10
Setting	11
Apple CarPlay/Android Auto	15
Radio operation	17
USB operation	17
Bluetooth Music	18
Bluetooth Phone	19
SiriusXM Ready	20
Camera in	26
Specification	27
Trouble Shooting	28
FCC Notes	29

Safety First

Safety Definitions

Statements in this manual preceded by following words are of special significance:

▲ WARNING

WARNING indicates a potentially hazardous situation which, if not avoided, could result in death or serious injury.

▲ WARNING

Set volume levels and other controls on audio and electronic devices before riding. Distractions can lead to loss of control, resulting in death or serious injury.

▲ WARNING

Do not select a volume level that blocks out traffic noise or interrupts the concentration necessary for the safe operation of the Motorcycle. Distractions or a volume level that blocks our traffic noise could cause loss of control resulting in death or severe injury.

Note

Pay attention while riding, keeping your eyes and clear mind on the road. Some features are locked out to prevent distraction, limited in capability while the Motorcycle is in motion. Even a part is available, do not allow it to distract you from operating your Motorcycle safely.

For safety, program the system when stopped. Perform system setup and get familiar with the controls and features of the infotainment system before operating the Motorcycle on the road. This system cannot warn about the safety of an area, bad road conditions, and availability of emergency services.

Use this radio only in locations where it is safe to do.

Pre-RIDING

Check list

Configure the system with your personal preferences before riding to use features and minimize distractions while on the road entirely.

1. Set brightness, background.
2. Configure presets.
3. Adjust audio settings like EQ, volume, fade, balance etc. before ridding.
4. Pair, connect and set up phone features through Bluetooth.
5. Connect USB devices for Apple CarPlay® or Android Auto®.
6. Selectstation or media

CARE AND CLEANING

Use only **HDHU.98135G** recommended products and methods to keep the radio, speakers, and other audio system components clean and in good condition.

Do not use any abrasives, polishes, or rubbing compoundsto clean the screen or other components. Do not use any ammonia-based cleaners on the net.

The use of other products or methods may cause damage to components.

Screen :

Do not use any chemical cleaners or chemical-containing wipes or cloths. These can cause damage to the screen surface.

Gently clean the display glasssurface with a clean, dry microfiber cloth. Before cleaning, it is suggested to remove any visible dust, dirt, sand particles with a gentle compressed airstream.

Appearance



Front

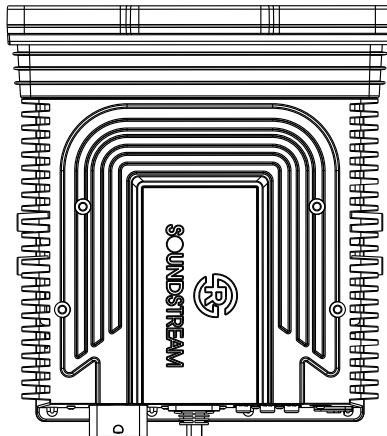

Top

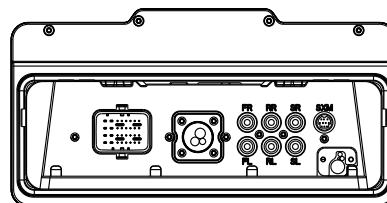

Back

Accessories and Installation

Harness Included!

23 Pin to Motorcycle

Connector to Headunit

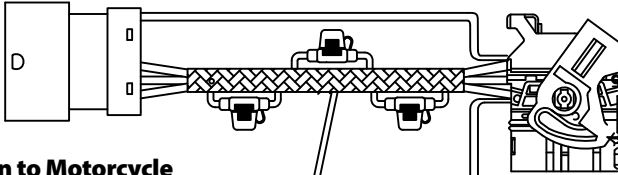

35 Pin to Motorcycle



35 Pin to Motorcycle

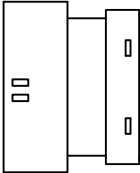

Installation Rubber Ring:

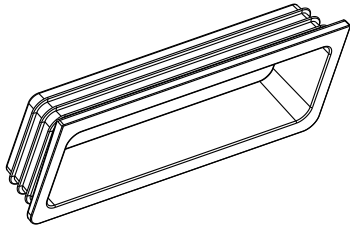

User Manual



Installation Screws (4pcs):



External Microphone:

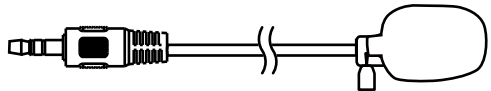

Headunit Control

Panel Control.

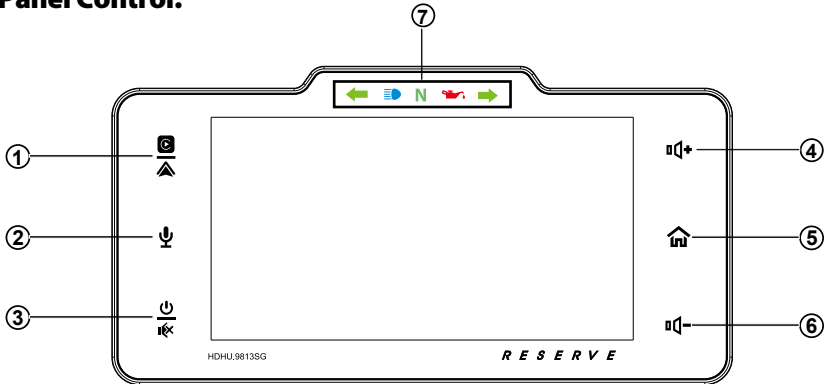

1 Apple CarPlay® / Android Auto®

Press to enter CarPlay® / Android Auto® directly(When the iPhone/Android phone is connected).

2 Siri Button (Voice Recognition)

When the iPhone/Android phone is connected, press **Siri** button to start the voice control function.

3 Power / Mute

- When the power is off, press to power on.
- When the unit is working, short pressing for Mute, press again for unmute.
- Pressing and hold to turn the source unit power off.

4 (Volume +)

- Press to increase the volume value.

5 Home button

- Press to toggle between Home screen and active media.
- Available selections: Radio, SiriusXM, Apple CarPlay®/Android Auto®, BT Music, BT Phone, USB,Settings, Camera in.

6 (Volume -)

- Press to decrease the volume value.

7 (LED indicator)

- When the receive the signal, the corresponding Icon will be lighted.

Headunit Control

Handle Bar Control.

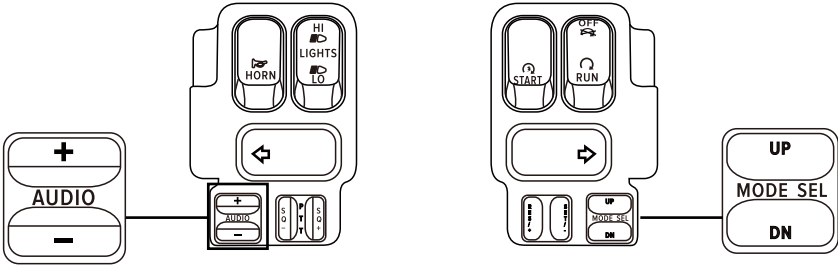

+ · Press to increase the volume value.



AUDIO

Mute Button

· When the unit is working, short pressing for Mute, press again for unmute.

Siri Button (Voice Recognition)

· When the iPhone/Android phone is connected, Long press **this** button to start the voice control function.

- · Press to decrease the volume value.

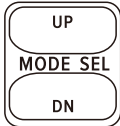

MODE SEL

UP · **[Radio]** Press to select Next preset radio station for broadcasting. Press and hold to seek upward .

· **[USB Music]** Press repeatedly to shift track next for playback. Press and hold to active various fast forward speeds for playback.

[Bluetooth Music] Press repeatedly to shift track next for playback.

Mode Button

· When the unit is working, press to select desired playback mode.

Bluetooth Button (Bluetooth Connected)

· When incoming call, short press to answer the call, long press to reject the call.

· When talking call, long press to hangup.

DN · **[Radio]** Press to select previous preset radio station for broadcasting. Press and hold to seek downward .

· **[USB Music]** Press repeatedly to shift track previous for playback. Press and hold to active various fast rewind speeds for playback.

[Bluetooth Music] Press repeatedly to shift track previous for playback.

Wiring

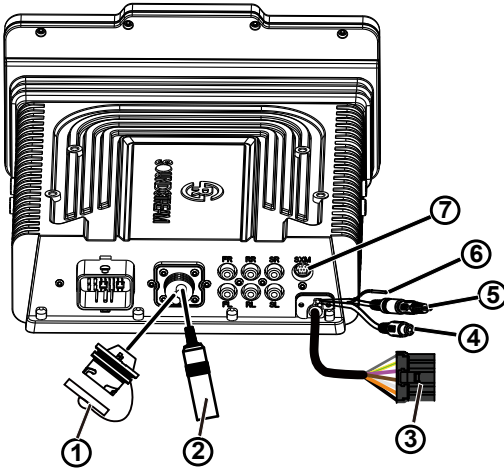

1 USB Connector

Connect the external USB cable for USB device, Android smart phone, iPhone.

2 Radio Connector

Connect the Radio Antenna from motorcycle.

3 Indicator LED wire

Connect the indicator signal wire from motorcycle.

4 Camera in

Connect the Camera in.

5 External Microphone Connector

Connect the external Microphone cable.

6 Camera +12 V DC (Max 0.5A)

Connect the Camera power cable.

7 SiriusXM Tuner Connector

Connect the SXV300 tuner.

Note: SiriusXM SXV300 Tuner sold separately, SiriusXM subscription required.

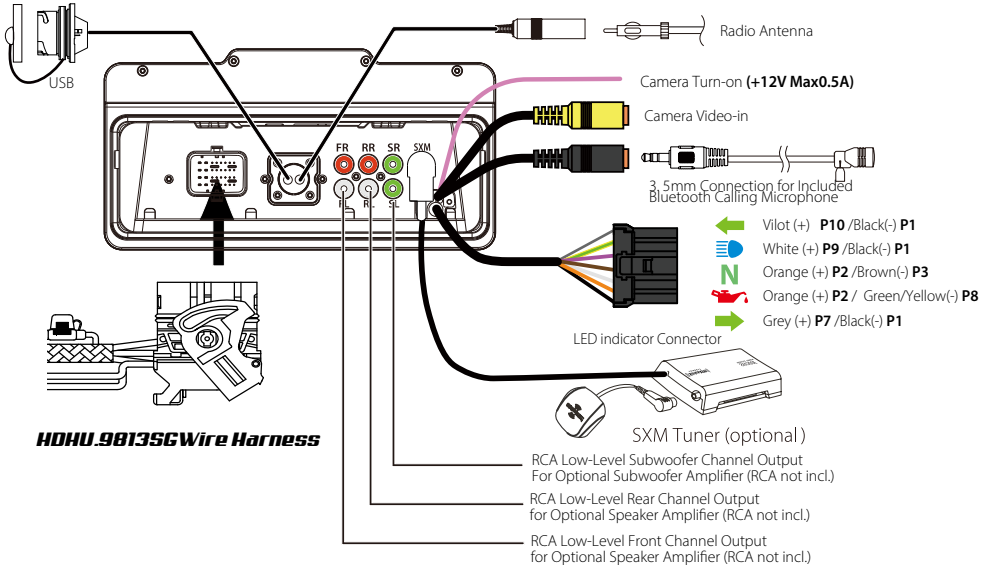

HDHU 9813SG Wire Harness

Wiring

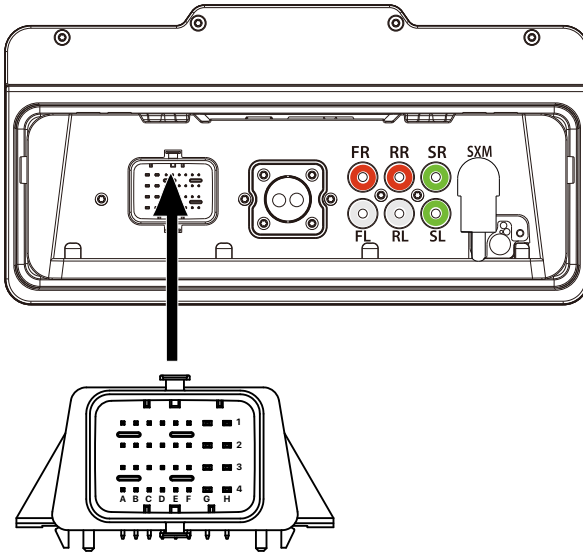

32 Pin Connector Pin Definition:

			D1, Green/Black(RL-)
			D2, Red(ACC)
A3, Blue(SWC R2)			
A4, Blue(SWC C1)	B4, Blue(SWC C0)	C4, Blue(SWC C2)	D4, Blue(SWC C4)
E1, Green(RL+)	F1, Purple/Black(RR-)	G1, White/Black(FL-)	H1, Gray/Black(FR-)
	F2, Purple(RR+)	G2, White(FL+)	H2, Gray(FR+)
E3, Blue(REM)		G3, Black(Ground)	H3, Yellow(B+)
E4, Blue(SWC R0)	F4, Blue(SWC R1)	G4, Black(Ground)	H4, Yellow(B+)

Included Harness

Harness Included!

23 Pin to Motorcycle

Connector to Headunit

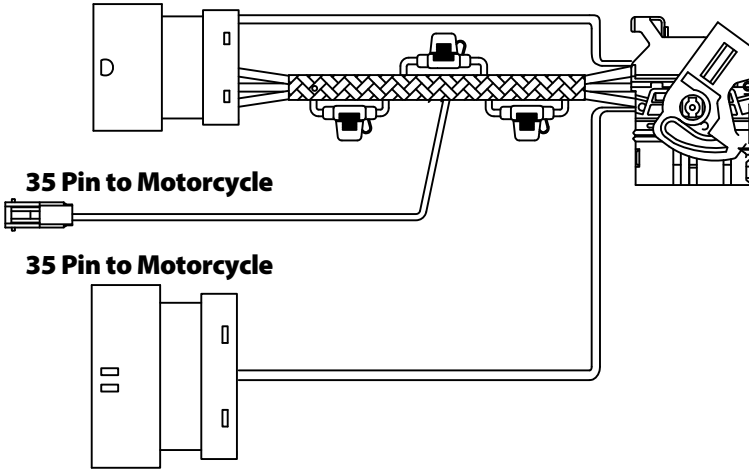

35 Pin to Motorcycle

35 Pin to Motorcycle

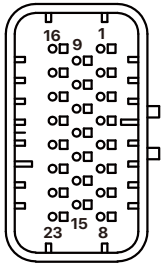

23 Pin Connector

- P1, Gray/Black(FR-)
- P3, Blue(SWC R0)
- P4, Blue(SWC R1)
- P5, Blue(SWC R2)
- P6, Blue(SWC C4)
- P8, Blue(SWC C2)
- P10, Yellow(B+)
- P11, Black(Ground)
- P12, Red(ACC)
- P16, White(FL+)
- P17, White/Black(FL-)
- P18, Gray(FR+)
- P19, Black(Ground)
- P20, Yellow(B+)
- P22, Blue(SWC C1)
- P23, Blue(SWC C0)

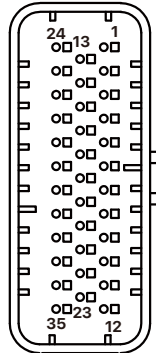

35 Pin Connector

- P1,20#, Purple(RR+)
- P2,20#, Green(RL+)
- P24,20#, Purple/Black(RR-)
- P25,20#, Green/Black(RL-)



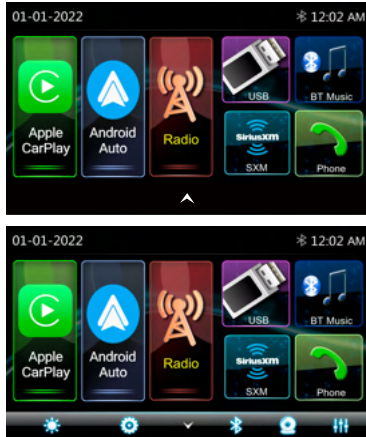

Main Menu

HDHU.9813SG is a headunit for Motorcycle with the following functions: Apple CarPlay®, Android Auto®, Radio, USB, BT Music, Phone, Camera, SiriusXM ready . Touch the corresponding Mode icon to enter playing mode. The Mode icon in gray means the corresponding function is not ready, or the proper device has not been connected.



Hidden soft button bar:

A hidden pop up soft button bar is located at the bottom. Touch the icon ▲ to shown the soft button bar. Touch the ▼ to hidden.

-  Dimming, to change Daylight or Night.
-  Setup, to enter the Settings Menu.
-  Bluetooth pairing.
-  Camera in.
-  EQ, to enter the Equalizer setting menu.

Settings

Touch the  icon to enter the Setup menu.

The Setup menu is included System Settings, Display Settings, Audio & EQ Settings, Bluetooth Settings.

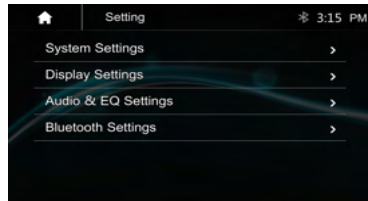

System Settings:

The System Settings allow the user to set up the Language, Date & Time, Key Beep, Factory Reset and About

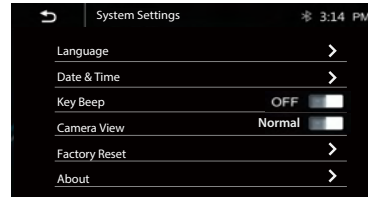

Language:

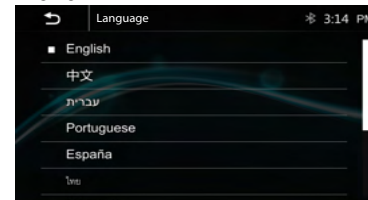

Date & Time:

To setting Time display format (12H or 24H), setting the date and time

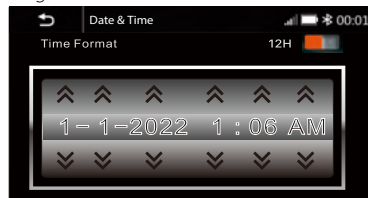

Settings

Key Beep: On / Off

To set the touch button beep tone is On or Off.

Camera View: Normal / Reverse.

To set the camera view is Normal or Reverse.

Factory Setting:

To default the default factory settings:



About:

To display the **HDHU.9813RG** hardware and firmware version.

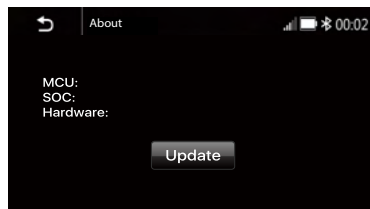

Display setting:

Below is the Display setting menu, user can select **Nighttime Brightness, Touch Key Color, Background Wallpaper.**

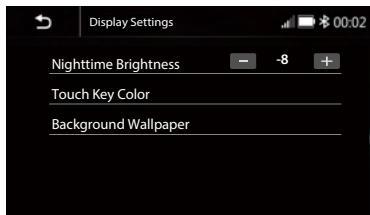

Nighttime Brightness : -15 – 0. (Default is -8).

Touch Key Color



Auto Changing Colo : On/Off .

ON: The Led color will change automatically.

OFF: You press the button  or  to select desired color.

Color: White / Red / Orange / Yellow /Blue / Green / Purple / Cyan.

Background Wallpaper:

User can select the preset wallpaper or select prefer picture in USB driver as the wallpaper.

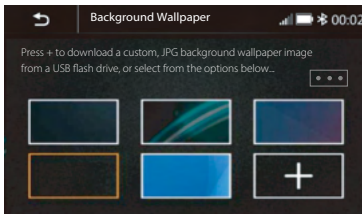

Touch the corresponding picture to select the prefer background.

Touch "+", the head unit will search the USB photo file for wallpaper.

Select a picture and touch **"OK"** to add the wallpaper.

 Select another picture for replacing the current wallpaper.

Settings

Audio & EQ Setting

Below shown is the Audio setting Menu.

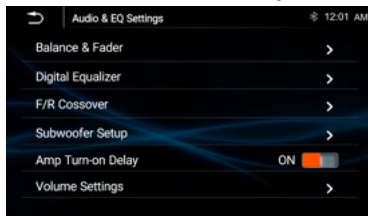

Balance/Fader:

Touch the + or – of Balance/Fade to tune for the driver and passenger preference.

The value of **Balance (Left 12 – Right 12)** and **Fader (Front 12 – Rear 12)**.

Touch Reset to set both **Balance** and **Fader** to zero.

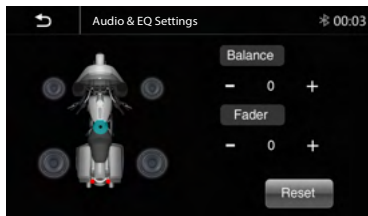

13-Band Equalizer:

13-band of EQ tuning, slide the EQ bar to tune each band frequency level according to use preference.

Touch Reset button to sell all Band to zero.

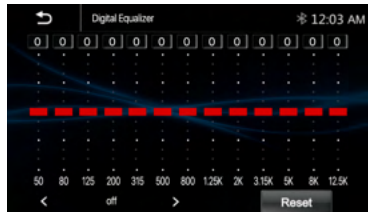

Or user can touch “<” or “>” at the bottom to select the following preset EQ:
Off, Soft Rock, Pop, Electric, Jazz, EQ Custom.

About the Crossover

This unit is equipped with an active crossover. The crossover limits the frequencies delivered to the outputs.

The crossover adjusts the HPF (high pass filter) or LPF (low pass filter) of speakers and subwoofer, and also the slope (how fast the filter rolls off the highs or lows).

Adjustments should be made according to the reproduction characteristics of the speakers. Depending on the speakers, a passive network may not be necessary. If you are unsure about this point, please consult your authorized Alpine dealer.

- **HPF (high pass filter):** Cuts the lower frequencies and allows the higher frequencies to pass.
 - **LPF (low pass filter):** Cuts the higher frequencies and allows the lower frequencies to pass.
 - **Slope:** The level change (in dB) for a frequency change.
 - The higher the slope value, the steeper the slope becomes.
 - Do not use a tweeter without the HPF set on, with a high cut-off frequency, otherwise damage may occur to the speaker due to the low frequency content.
 - **Adjustment** should be made according to the recommended crossover frequency of the connected speakers. Determine the recommended crossover frequency of the speakers. Adjusting to a frequency range outside that recommended may cause damage to the speakers.
- For the recommended crossover frequencies of speakers, refer to the respective Owner's Manual.
- We are not responsible for damage or malfunction of speakers caused by using the crossover outside the recommended value.

Settings

Front/ Rear Crossover:

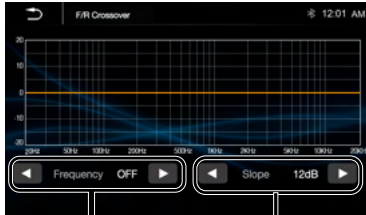

Slope: 12dB / 24dB

User can touch "<" or ">" to select the desired frequency Value.

Subwoofer Settings:



Subwoofer Output: ON or OFF.

Subwoofer Level: -10~+10

Subwoofer Crossovers:

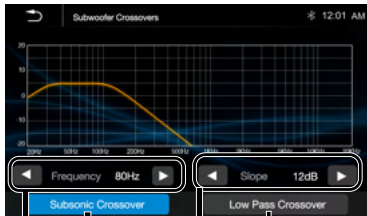

Set Low Pass Crossover Frequency & Slope.

Slope: 12dB / 24dB

Set High Pass Crossover Frequency & Slope.

User can touch "<" or ">" to select the desired frequency Value.

Subwoofer Phase: 0° or 180°

User can touch "<" or ">" to select the 0° or 180°

AMP Turn-on Delay: ON/OFF.

User can set AMP Turn-on Delay is ON or OFF.

Volume Settings:

User can set Source Level / Maximum Volume.



Source Level Adjust.



User can adjust the source mode (Radio, USB, BT Audio, Apple CarPlay, Android Auto, SiriusXM) gain value. The gain can be adjusted from -10~0 separately.

Maximum Volume Adjust.



Maximum Volume Level: ON or OFF.

Maximum Level Adjust: -40~+50

Settings

Bluetooth Settings:

Touch the Bluetooth Settings from the setting menu will be shown below:

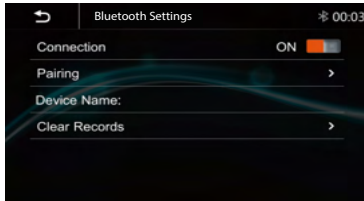

Connection: On/Off (Select Bluetooth connection is On or Off).

Pairing: To start the paring.



Device Name: Shown the connected phone or device name.

Clear Records: To clear the device list records.

Apple CarPlay®

Apple CarPlay :

You can operate iPhone applications with finger gestures such as tapping, dragging, scrolling, or flicking on the screen of this product.

Compatible iPhone models

For details about compatibility of iPhone models, refer to the following website.
<https://www.apple.com/ios/carplay>

WARNING

Certain uses of the iPhone may not be legal while driving in your jurisdiction, so you must be aware of and obey any such restrictions. If in doubt as to a particular function, only perform it while the car is parked. No feature should be used unless it is safe to do so under the driving conditions you are experiencing.

Notes on using Apple CarPlay

- iPhone with iOS 7.1 or later is required. Update to the latest iOS version before use.
- Apple CarPlay can be used on iPhone 5 or later.
- For details on compatible models, refer to the compatibility list on the support site on the back cover.
- For details about Apple CarPlay, refer to the manual supplied with your iPhone, or visit the website of Apple CarPlay.
- Since the GPS on your iPhone is used, place your iPhone where it can easily receive a GPS signal
- You can use Siri function by touching  button once Apple CarPlay is activated
- The Bluetooth connection with the Apple CarPlay compatible device will be terminated automatically if Apple CarPlay is turned on.
- Hands-free phoning via Bluetooth wireless technology is not available while Apple CarPlay is on.

Starting procedure of using Apple CarPlay

- 1 Connect an Apple CarPlay compatible device to this unit via USB.
 - 2 Touch the Apple CarPlay icon.
- The Apple CarPlay home screen appears.

You can use Apps of connected iPhone. The items displayed and the language used on the screen differ among the connected devices. To enter the Apple CarPlay mode, touch Apple CarPlay icon on the Home selection screen.

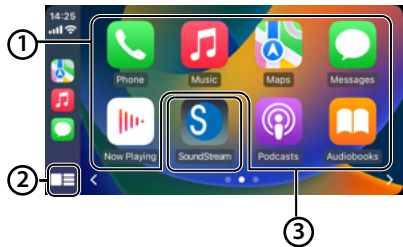

① Application keys

Start the application.



Display the home screen of Apple CarPlay. Touch and hold to active Siri.

③ Home

Exit the Apple CarPlay screen and displays Home screen.

* The icon design may change depending on the iOS version.

Android Auto®

Android Auto®:

You can operate Android applications with finger gestures such as tapping, dragging, scrolling, or flicking on the screen of this product

Starting procedure of using Android Auto

1 Connect an Android Auto™ compatible device to this unit via USB.

2 Touch the Android Auto icon.

The Android Auto home screen appears

Note:

- You can use Voice function by touching  button once Android Auto is activated.

- The Bluetooth connection with the Android Auto compatible device will be terminated automatically if Android Auto is turned on.
- Hands-free phoning via Bluetooth wireless technology is not available while Android Auto is on.

Notes on using Android Auto

- Android phone with Android 5.0 or higher is required. Update to the latest OS version before use.
- Your Android phone needs to support Android Auto. For details on compatible models, refer to the compatibility list on the support site on the back cover.
- Download the Android Auto app on Google Play.
- For details about Android Auto, refer to the manual supplied with your Android phone, or visit
- Since the GPS on your Android phone is used, place your Android phone where it can easily receive a GPS signal.
- Android Auto may not be available in your country or region.the website of Android Auto.

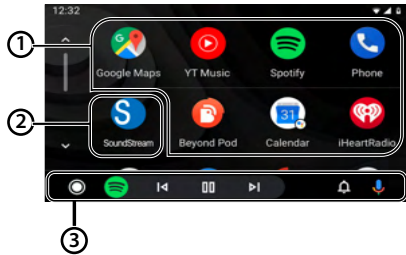

① Application keys

Start the application.

② Home

Exit the Android Auto screen and displays Home screen.

③ Operation Bar

Starts the application or displays information.

Radio

Touch "Radio" in the main menu to enter the radio interface.



Touch "FM" can change between FM1>FM2>FM3.



Touch "AM" can change between AM1>AM2.
Touch "GOTO" then Pop-up the GOTO menu and enter the desired Frequency Number.

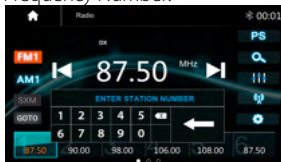

Touch for Prescan search, each scanned station will be played for 10 sec, touch again to stop. Touch to auto scan searching.



Touch to enter EQ settings.



Touch to switch Local or DX.



Touch to enter Radio settings.



Short touch to seek down, long touch to tune down.



Short touch to seek up, long touch to tune up.

Preset channel, six preset buttons store and recall stations for each band. Touch and slide the preset channel can switch to next band FM1/FM2/FM3 or AM1/AM2.

Store a Station

1. Tune radio to desired station.
2. Touch and hold the one of the preset station

USB

for more than 3 seconds, then the preset button will be highlighted on the screen, and the preset station will be stored.

Radio setting:



Radio Area: Select the region , America/Europe /Eastern Europe /Japan /Southeast Asia /Latin America/ Asia / Australia.

RDS: Switch ON or OFF.

TA: Switch ON or OFF.

AF: Switch ON or OFF.

PTY: Enter PTY list.

Note: AF is only for Europe region.

USB

Plug the USB; the USB icon will be colorful. Touch the USB icon to enter the USB playback mode. The source unit will playback the audio in the USB device.



Press to go to the following folder.









Press to search Audio/Image files.



Press to go to the previous folder.



USB

-  Short press to skip previous track.
Long press to fast reverse.
-  Play or Pause button.
-  Short press to skip next track.
Long press to fast forward.
-  Press to select Repeat All >
Repeat 1 > Repeat Folder.
-  Press to switch Random is
On or Off.
-  Press to select Audio setting or
set the preferred EQ of each
band in custom mode.

File List Browsing

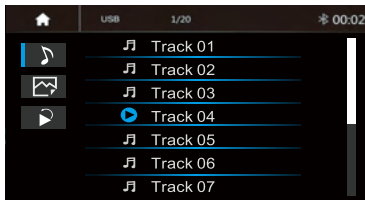
Touch  to browse the folder and file list of the USB device.







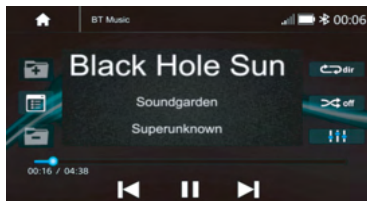

-  Select Audio or Music files.
-  Select Picture files.
-  Return to playing previous file.

Bluetooth Music:

Touch the BT Music icon to enter Bluetooth Music playing mode. If the Bluetooth is connected, the music will be playing as below shown:



Bluetooth Music

-  Press to search Audio files.
-  Short press to skip previous track.
-  Play or Pause button.
-  Short press to skip next track.
-  Press to select Repeat All >
Repeat 1 > Repeat Folder.
-  Press to switch Random is
On or Off.
-  Press to select Audio setting or
set the preferred EQ of each
band in custom mode.

Bluetooth Connect:

If the Bluetooth is not connected, press Reconnect the paired Phone or pairing to pair the new device.



Bluetooth Pairing:

Pairing screen will be shown as below:

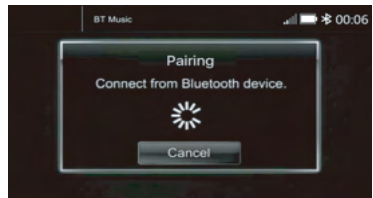

Turn on the Bluetooth of the Mobile phone/ Bluetooth device; you can see the **"SOUNDSTREAM HD"**. Select the **"SOUNDSTREAM HD"** for pairing and connection.

Bluetooth Phone

Bluetooth Phone:

After the mobile Phone is connected with the source unit via **Bluetooth(HFP)**, the user can go through the source unit.

Make a phone call. Touch the Phone icon in Main Menu to go to BT Phone mode. Please note it needs to connect the microphone for phone calls.



Keypad. Tap it to enter call mode.



History. Tap it to show the call record, missed, received and dialed calls.



Contact. Tap it to show the phonebook of connected device.



BT Setup. Tap it to set Auto answer and Microphone gain.







Make a call or Accept the incoming call.



Backspace, tap it to clear the incorrect dial digit.

Make a Call:

1. Touch the  icon to enter dial screen.
2. Using the keypad, touch 0-9,*,# , enter the desired number to dial. If you input an incorrect number, touch the  icon on the keypad to delete the incorrect number.
3. Once the correct number appears on the screen, touch the  icon to go to dialing interface.
4. To end the call, touch the icon  on the screen.

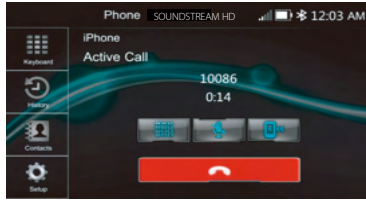

Receive an incoming call:

If the Phone is connected with the source unit via Bluetooth, when an incoming call, below screen will be shown:

Press  to answer the incoming call.

Press  to reject the incoming call.



Interchange between phone and source unit.



ON / OFF the Microphone function.



Display the Keypad.

Bluetooth Phone

Call List:

Touch the  icon to display the call combined list.

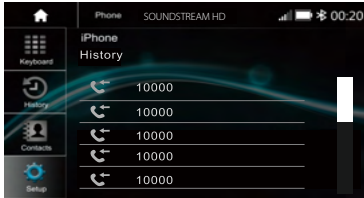

Slide the bar at the right up and down to display a call logs.

Contacts:

Touch the icon  to access the phone book of the connected mobile Phone. To make a call from the phonebook, simply touch the contact's name

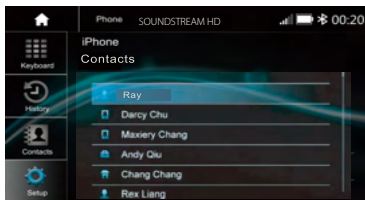

BT Setup:

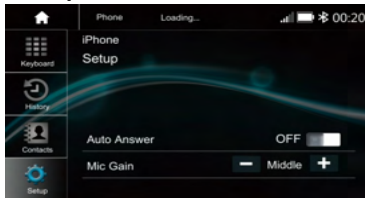

Auto Answer On/Off, incoming call auto answer.

MIC Gain: Low /Middle /High

SiriusXM Operation

SiriusXM Ready

SiriusXM is where moments happen. The widest, deepest variety of music, ad-free. More games, more sports, more coverage than anywhere. The most extensive entertainment, complete news coverage and every kind of comedy. Listen in your car, on your phone, online and at home. A SiriusXM Vehicle Tuner and subscription are required. For more information, visit www.siriusxm.com.

Activating your SiriusXM Subscription after installing your SiriusXM Connect Vehicle Tuner and antenna, power on your Headunit and select SiriusXM mode. You should be able to hear the SiriusXM preview channel on Channel 1. If you cannot hear the preview channel, please check the installation instructions to make sure your SiriusXM Connect tuner is properly installed.

After you can hear the preview channel, tune to **Channel 0** to find the **Radio ID** of your tuner. In addition, the Radio ID is located on the bottom of the SiriusXM Connect Vehicle Tuner and its packaging. You will need this number to activate your subscription. Write the number down for reference.

Note: the SiriusXM Radio ID does not include the letters I, O, S or F.

In the **USA**, you can activate online or by calling SiriusXM Listener care:

- Visit www.siriusxm.com/activatenow
- Call SiriusXM Listener Care at

1-866-635-2349

For **Canadian** Subscriptions, please contact:

- Visit www.siriusxm.ca/activate
- Call SiriusXM Customer Care at

1-888-539-7474

As part of the activation process, the SiriusXM satellites will send an activation message to your tuner. When your radio detects that the tuner has received the activation message, your radio will display "Subscription Updated".

Once subscribed, you can tune to channels in your subscription plan. Note, the activation process usually takes 10 to 15 minutes, but may take up to an hour. Your radio will need to be powered on and receiving the SiriusXM signal to receive the activation message.

SiriusXM Ready

To enter SiriusXM mode, touch the SXM icon on the Main Menu:



If the **CHECK TUNER** message appears, verify all connections are complete. Confirm the Vehicle Connect Tuner is connected, as well as the antenna for the Vehicle Connect Tuner.

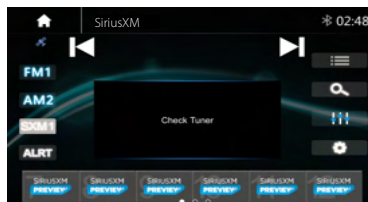

When successfully connected, the user interface will appear:



SiriusXM Channel Logos are displayed in the user interface, providing a graphical representation of the current channel tuned. Album art can be displayed for most of the SiriusXM music channels. When album art is not available, the channel logo or the SiriusXM logo will be displayed.

Note: Compatible with SXV200 or later tuner models. Not all music channels contain album art images.

User Interface Operation

- FM1** Press FM or AM keys to toggle between SXM & FM/AM radio mode
- AM2**
- SXM1** Press the SXM key to toggle between three preset groups
- ALRT** Press the ALRT key to view current song and/or artist alerts
- Press the Channel Browse key to scroll channel listings by category
- Press the Direct Tune key to enter a specific channel number to tune
- Press the EQ key to open the 10-band equalizer settings
- Press the Settings icon to access settings specific for SiriusXM mode
- Press the Next or previous channel keys to advance channels
- Press any preset key to tune the stored channel. To store a preset, tune to the desired channel, then press & hold on the preset location for 3 seconds.

Artist & Song Alerts **ALRT**

While listening to SiriusXM Satellite Radio, you can mark Artists and/or Songs for which you wish to be alerted. The radio will display an Alert message when a matching artist or song is found on another channel. Then you can choose if you want to tune to that favorite or you can ignore the alert and stay on your current channel. To save an artist or song title, press on the artist name or song title on the screen. Then, confirm again to save the favorite.

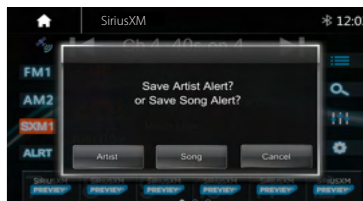

SiriusXM Operation

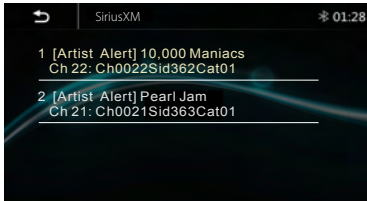

Channel Browse

Press the Browse key to scroll channel listings by category or all available channels.

Channel List

Press **Ch. List** to view all available channels in numeric sequence. Scroll the list to the desired channel, then select within the channel row to tune the channel.

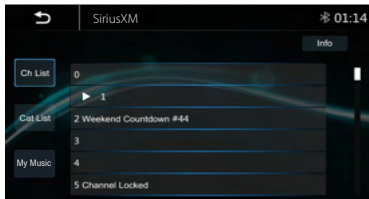

Category List

Press **Cat. List** to view all available channels in category sequence.





Select a category by pressing the left or right arrows above the channel list. Scroll the corresponding category's channels below, press a channel name to tune the channel.

Info

At any time, press the content key on the right side to view the artist, title, & other information about the song/content currently playing on the channel(s) listed.



My Music

Press the MyMusic key to view all stored artist & song title alerts. Press the red X  at right of any undesired alerts to delete it. Temporarily disable any alert by deselecting the check box  Som left of any alert.

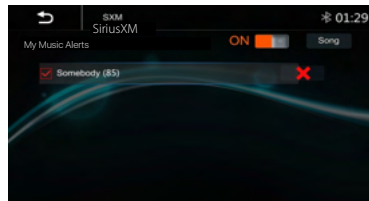
Disable all alerts by sliding the switch on top to off.



Direct Tuning a Channel

Press the Direct Tune key to enter a channel number to tune. Enter the channel number using the keypad pop-up, then select the green check box  to confirm your selection. If a number is entered in error, press the red backspace  key to erase the last digit.



SiriusXM Operation

13-Band Equalizer



Press the 13-Band Equalizer key to access the audio equalizer settings. Return to the Audio & EQ Settings section of this owners manual (pg. 13) for more information.

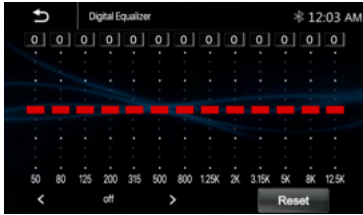

SiriusXM Settings Menu



Press the settings icon to enter the SiriusXM settings menu.

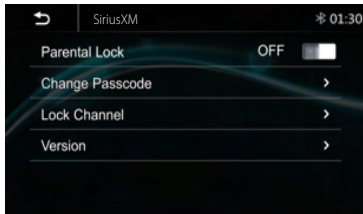

Parental Controls

The Parental Lock feature can be used to block user selected channels from playback. To enable the parental lock, slide the virtual switch to ON. The switch should illuminate orange. A passcode pop-up will appear, requesting the parental lock passcode. Enter the 4-digit passcode, then select the green check box to confirm. If a number is entered by mistake, press the red backspace key to erase the last digit. The default passcode is 0000.

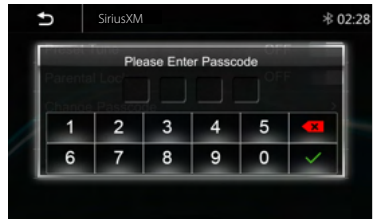

Then, the channel list will appear to scroll the subscribed channels. Select any channel(s) to lock. When a channel is successfully locked, a lock icon will appear adjacent to the channel name.

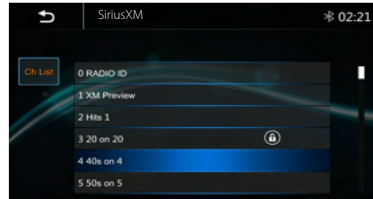



Change Passcode

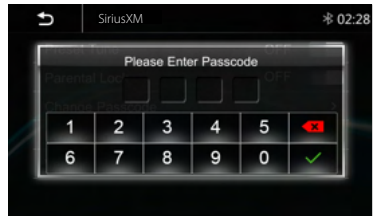

Select Change Passcode to change the passcode required to activate the parental lock feature and to lock & unlock channels. A passcode pop-up will appear, requesting the current passcode. Enter the 4-digit passcode, then select the green check box to confirm. If a number is entered by mistake, press the red backspace key to erase the last digit. The default passcode is 0000.



SiriusXM Operation

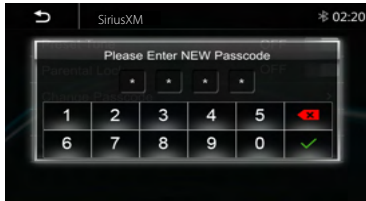

Then, another passcode pop-up will appear, requesting the new passcode. Enter the 4-digit passcode, then select the green check box  to confirm. If a number is entered by mistake, press the red backspace key  to erase the last digit.

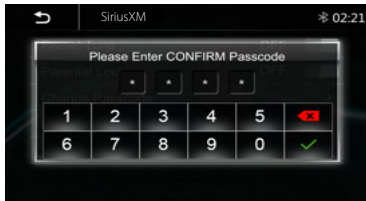

Then, a third & final passcode pop-up will appear, requesting to enter the new passcode again to the green check box  to confirm. If a number is entered by mistake, press the red backspace key  to erase the last digit.



Lock Channel

Select Lock Channel to lock or unlock channels from playback. A passcode pop-up will appear, requesting the current passcode. Enter the 4-digit passcode, then select the green check box  to confirm. If a number is entered by mistake, press the red backspace key  to erase the last digit. The default passcode is 0000.

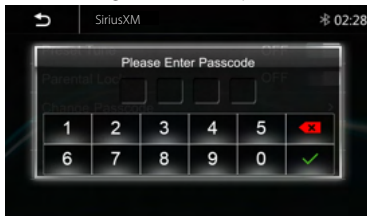

Then, the channel list will appear to scroll the subscribed channels. Select any channel(s) to lock or unlock. If a channel is successfully locked, a lock icon will appear adjacent to the channel name.

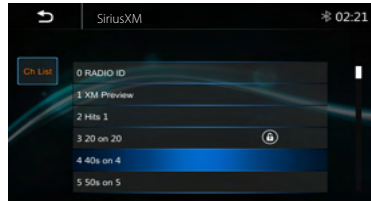

SiriusXM trouble shooting

Advisory Message	Cause	Explanation / Solution
Check Antenna	The radio has detected a fault with the SiriusXM antenna. The antenna cable maybe either disconnected or damaged.	<ul style="list-style-type: none"> -Verify that the antenna cable is connected to the SiriusXM Connect Vehicle Tuner. -Inspect the antenna cable for damage and kinks. Replace the antenna if the cable is damaged. -SiriusXM products are available at your local car audio retailer or online at: shop.siriusxm.com/all-parts/
Check Tuner	The radio has difficulty communicating with the SiriusXM Connect Vehicle Tuner. The tuner may be disconnected or damaged.	Verify that the SiriusXM Connect Vehicle Tuner cable is securely connected to the radio
No Signal	The SiriusXM Connect Vehicle Tuner has difficulty receiving the SiriusXM satellite signal.	<ul style="list-style-type: none"> -Verify that your vehicle is outdoors with a clear view of the sky. -Verify that the SiriusXM magnetic mount antenna is mounted on a metal surface on the outside of the vehicle. -Move the SiriusXM antenna away from any obstructions. Inspect the antenna cable for damage and kinks. -Consult the SiriusXM Connect Vehicle tuner installation manual for more information on antenna installation. Replace the antenna if the cable is damaged. SiriusXM products are available at your local car audio retailer or online at shop.siriusxm.com/all-parts/
Subscription Updated	The radio has detected a change in your SiriusXM subscription status.	<ul style="list-style-type: none"> -Press OK to clear the message. -In the U.S.A., visit www.siriusxm.com or call 1-866-635-2349 if you have questions about your subscription. -In Canada, visit www.siriusxm.ca/activate or call CustomerCare at 1-888-539-7474 if you have questions about your subscription. shop.siriusxm.com/all-parts/
Channel Unavailable	The channel that you have requested is not a valid SiriusXM channel or the channel that you were listening to is no longer available. You may also see this message briefly when first connecting a new SiriusXM Connect Vehicle tuner.	Visit www.siriusxm.com for more information about the SiriusXM channel lineup.
Channel Unsubscribed	The channel that you have requested is not included in your SiriusXM subscription package or the channel that you were listening to is no longer included in your SiriusXM subscription package.	<ul style="list-style-type: none"> -In the U.S.A., visit www.siriusxm.com or call 1-866-635-2349 if you have questions about your subscription. -In Canada, visit www.siriusxm.ca/activate or call CustomerCare at 1-888-539-7474 if you have questions about your subscription. shop.siriusxm.com/all-parts/
Channel Locked	The channel that you have requested is Locked by the radios Parental Control feature.	See the Parental Control section for more information on the Parental Control feature and how to access locked channels.

Camera in

Camera View

For connecting a camera.

Displaying the picture from the Camera

The camera view screen is displayed when you enter the Camra in.



Specification

GENERAL

Power Requirement:	DC 10 - 16Volts,
Power Requirement:	Negative ground
Current Drain:	15A (Max.)
Maximum Power Output:	50Watts x 4
RMS Power Output:	25Watts x 4
Speaker Impedance:	2- or 4-Ohm Load
Frequency Response:	20Hz ~20KHz
Operating temperature:	-20~60 °C
Dimensions:	230mm(W) x 210mm(D)x 140mm(H)

TFT Display

TFT Screen size:	7 – Inch TFT/LCD
Resolution	1024x600 pixels

FM RADIO SECTION

Frequency Range	87.5 – 107.9 MHz (America) 87.5 – 108 MHz (Europe)
Usabe Sensitivity (S/N=30dB)	≤15dB
S/N Ratio:	≥55dB
Stereo Seperation	≥30dB

AM RADIO SECTION

Frequency Range	(America) 530 – 1710 KHz (Europe) 522 – 1620 KHz
Usabe Sensitivity (S/N=20dB)	≤40dB
S/N Ratio:	≥45dB

Line-out / Subwoofer Output

Maximum Output Leve (10K ohms load):	≥4 V RMS
Subwoofer Time Align	0~18ms

Trouble Shooting

Problem	Cause	Correct action
No Power, Dead.	Check fuse	Replace fuse
	Incorrect wiring	Consult your Local Specialist. www.MotorcycleAudio.com/Specialist-Locator
No sound output when operating the unit with amplifiers or power antenna attached.	Power antenna lead is shorted to ground excessive current is required or remote on the amplifiers or power antenna	<ol style="list-style-type: none"> 1. Turn off the unit. 2. Remove all wires attached to the power antenna lead. Check each wire for a possible short to the ground using an ohm meter. 3. Turn on the unit. 4. Reconnect each amplifier remote wire to the power antenna lead one by one. If the amplifiers turn off before all wires are attached, use an external replay to provide remote-on voltage (excessive current required)
Poor performance of radiostation	Weak signal	Move the Motorcycle to another place, then try again
No Sound or Audio	Volume is in minimum.	Adjust volume to the desired level.
	The wiring is not properly connected	Check wiring connection.

FCC Notes

FCC Compliance

This device complies with Part 15 of the FCC Rules. Operation is subject to the following two conditions:

- (1) this device may not cause harmful interference, and
- (2) this device must accept any interference received, including interference that may cause undesired operation.

Warning: Changes or modifications to this unit not expressly approved by the party responsible for compliance could void the user's authority to operate the equipment.

Note: This equipment has been tested and found to comply with the limits for a Class B digital device, pursuant to Part 15 of the FCC Rules. These limits are designed to provide reasonable protection against harmful interference in a residential installation.

This equipment generates, uses and can radiate radio frequency energy and, if not installed and used in accordance with the instructions, may cause harmful interference to radio communications.

However, there is no guarantee that interference will not occur in a particular installation. If this equipment does cause

harmful interference to radio or television reception, which can be determined by turning the equipment off and on, the user is encouraged to try to correct the interference by one or more of the following **measures**:

- Reorient or relocate the receiving antenna.
- Increase the separation between the equipment and receiver.
- Connect the equipment into an outlet on a circuit different from that to which the receiver is connected.
- Consult the dealer or an experienced radio/TV technician for help.

www.MotorcycleAudio.com

Follow Us on Social Media

